

**Physical Attack Resistant Security Door Sets  
with Optional BR2 Bullet Rating**

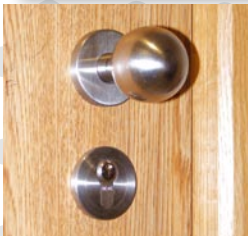

**Standard Specifications for 30 Minute  
Fire Resistant Internal Security Pass  
and ATM Door Sets**

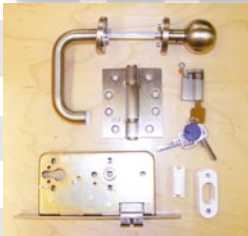

Nick Ellel - Contracts Manager, Gary Maybank - MD, Michael Parrott - Project Manager and Sarah Milner: PA.

Our company possesses the experience and expertise to accommodate all requirements and tastes, from quality bank fittings, counters, bars, board rooms, reception areas and offices, to bulk production of cashiers tills, security doors and frames, counter modules etc.

Which are manufactured to order and stored on our premises until called off by the customer.

We also act as main contractors employing our regular team of sub-contractors including mechanical and electrical, floor layers and decorators to carry out building refurbishment projects, varying in size from £1,000 to £600,000.

Our employees are all apprentice trained quality craftsmen who have worked for our company on a permanent basis for a number of years manufacturing and installing top quality french polished and spray lacquered fittings for contracts throughout the UK.

In our modern factory of 8,000 sq.ft we can pre-fabricate many of our contracts for quick and easy assembly on the site both during and out of normal working hours giving minimum inconvenience to our customers.

Our attention to detail, high standards and competitive rates have made us the first choice for customers such as Lloyds Bank for whom we have worked regularly over the past 50 years, also many other customers and various architects offices.

# Security Door - Performance Specification



## Fire Rating

The door sets are half hour rated BS 476: part 22: 1987, clauses 7 and 6.

## Frame

Solid hardwood throughout with double rebated closing stile and 25mm rebated stops for security. The double rebated stile has foam buffer fitted for noise reduction during closing. All factory finished with 10% sheen spray lacquer. Fire and smoke seals are fitted (if requested) to the frame to give the half hour fire resistance. Other materials and finishes are available on request.

## Door

45mm Birch throughout plywood core laminated in our factory in a high pressure heated press (this type of core is not available at any door blank supplier). The blank is edged with solid hardwood lippings, the closing edge lipping is rebated to fit the door frame in a radio frequency lipping machine under high pressure. The door edges are finished to match the frame. The faces are pressure laminated with either laminates or wood veneers to suit customer requirements.

## Ironmongery

The door furniture is high security and high quality stainless steel. Heavy duty ball bearing race hinges are protected with chubb hinge bolts, the locking is either by security cylinder nightlatch or deadlock or both depending on the type of door requested (please see separate ironmongery schedules for the different types of doors supplied). The lock strikes are either angled stainless steel or high security electric releases which may be linked to access control systems for remote entry.

Pass doors (and in some cases ATM doors) are fitted with a G2 bullet tested porthole vision panel with stainless steel frame and 32mm glass, the glass is wrapped in a 30 minute fire resistant blanket and sealed with fire retardant sealant. The frame gives a 300mm diameter clear vision line.

The porthole can if required be fitted with a lift up cover where sensitive areas need to be obscured from public view.

Additional lock protection can be provided via the use of a full length lock protection bar which covers the gap between the door and frame on the closing edge to prevent the lock bolt being levered out of its strike.

# Security Door - Performance Specification



## Door Types

There are currently 4 types of door sets, stand alone pass doors, interlock pass doors, stand alone ATM doors and interlock ATM doors.

## Flexibility and Finishes

Various finishes are available in either laminate, wood veneer, paint or primed to suit customer requirements.

Door sets are manufactured in varying sizes to suit existing structural openings and are also in some instances supplied with overpanels to the same specification as the doors.

## Packing

The door sets are packed in a solid packing case with polystyrene sheet protection internally, plywood sides and corner braces with compartment for door closer and keys. The faces are 6mm MDF with plywood rails to protect from puncture by truck loading.

## BR2 Bullet Resistant Option

Finishes and profiles are as described throughout this brochure but with a BR2 Rating. The frames have hidden steel angles and the door is made from an armour panel faced in MDF then lipped and finished to customer requirements.

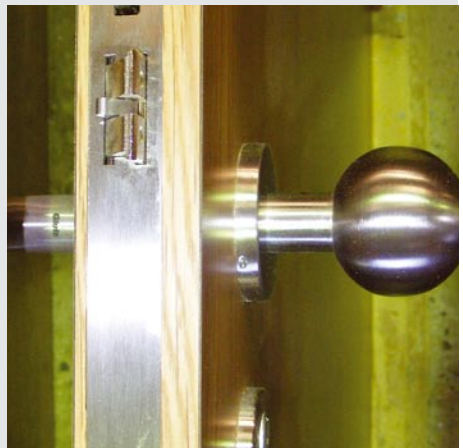

# Handing and Dimensions

## Right Handed Hung Door

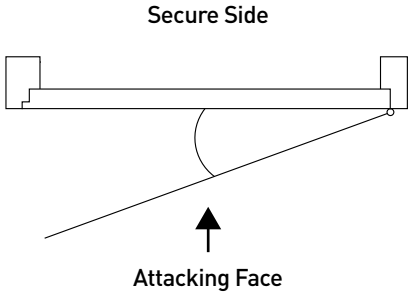

## Left Hand Hung Door

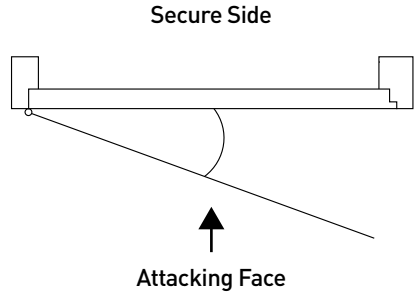

## Right Hand Inward Opening Door

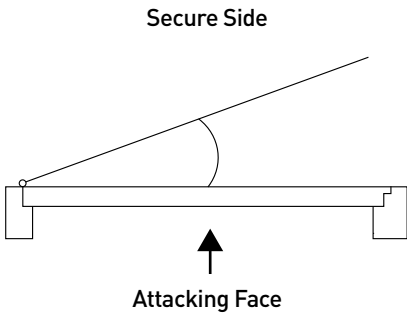

## Left Hand Inward Opening Door

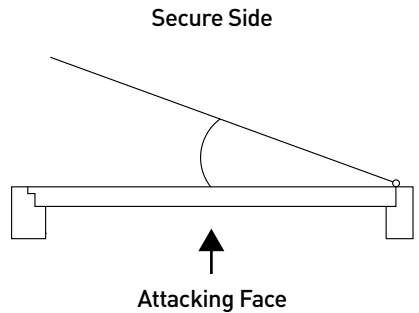

## Standard Outside Door Frame Sizes:

Stand Alone Pass Door Set	2090 x 944 x 125
Interlock Pass Door Set	2090 x 944 x 125
Stand Alone ATM Door	2090 x 1044 x 125
Interlock ATM Door	2090 x 1044 x 125

**Frames can be manufactured to non-standard sizes on request.**

# Stand Alone Pass Door Key Access Only

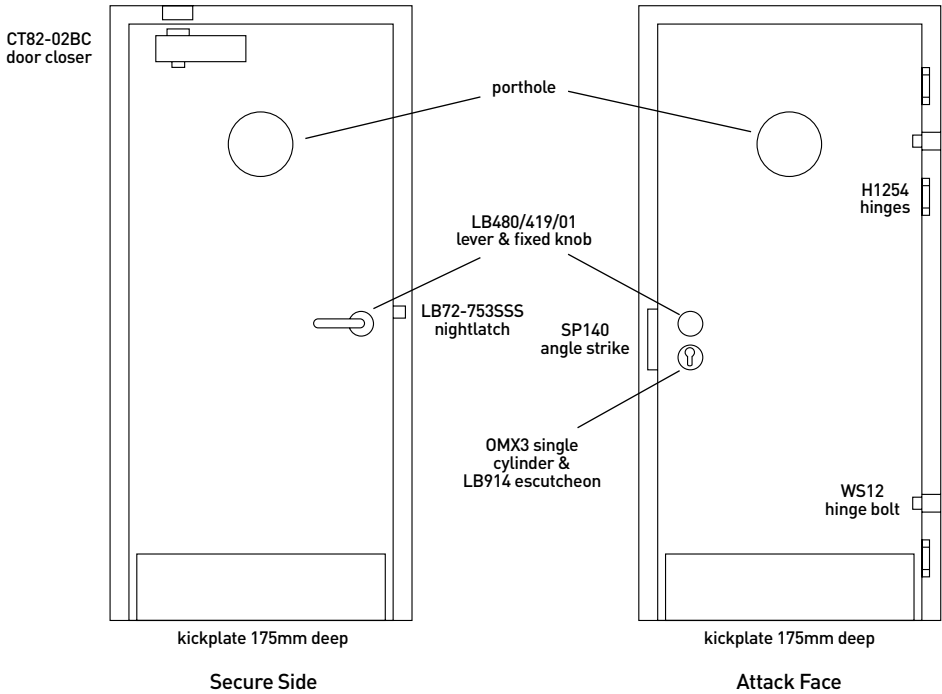

Lloyds	Dryad	Description	Qty
	H1254ES	125x93mm equal leaf fixed pin square cornered heavy duty	1.5
	LB72-753	Dryad Euro profile cylinder mortice nightlatch case SSS	1
	OMX3	45mm Euro profile single cylinder to differ SC	1
	SP140I	Angled strike plate SSS	1
	CT82-	Adjustable power overhead door closer with standard back-	1
	CT418/419/	External knob on rose fixed dead with internal lever on rose	1
	KICKPLATE	Kickplate 795x175mm SSS	1
	KICKPLATE	Kickplate 855X175mm SSS	1
	WS12	Chubb hinge bolts White (pair)	1
	LBCT914	Euro profile escutcheon SSS (each)	1
		Porthole	1

# Stand Alone Pass Door Key Fob and Key Access

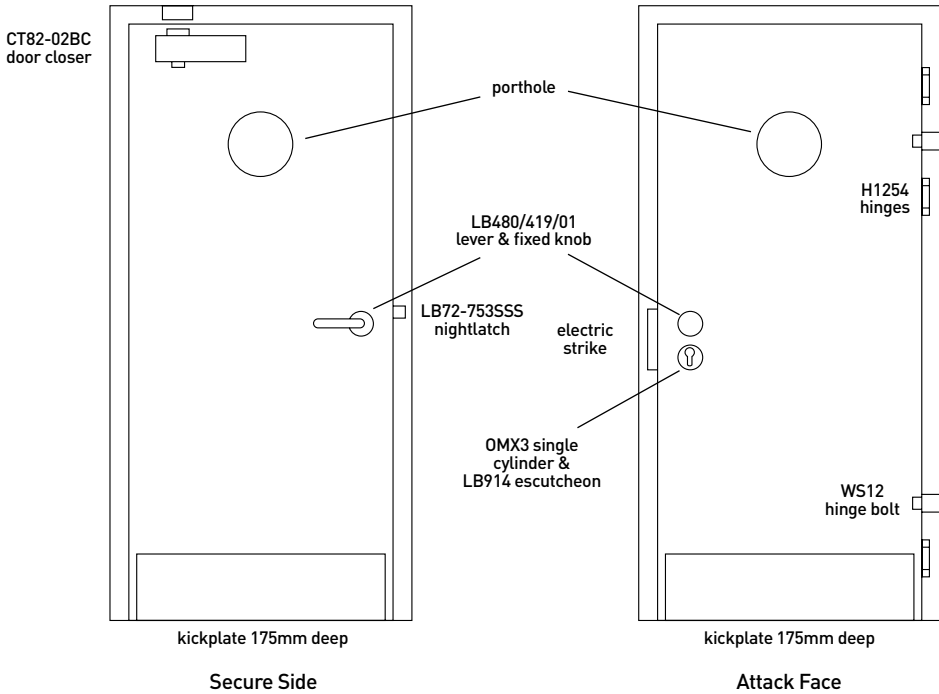

Lloyds	Dryad	Description	Qty
	H1254ES	125x93mm equal leaf fixed pin square cornered heavy duty	1.5
	LB72-753	Dryad Euro profile cylinder mortice nightlatch case SSS	1
	OMX3	45mm Euro profile single cylinder to differ SC	1
	CT82-	Adjustable power overhead door closer with standard back-	1
	CT418/419/	External knob on rose fixed dead with internal lever on rose	1
	KICKPLATE	Kickplate 795x175mm SSS	1
	KICKPLATE	Kickplate 855X175mm SSS	1
	WS12	Chubb hinge bolts White (pair)	1
	LBCT914	Euro profile escutcheon SSS (each)	1
		Electric Strike	1
		Porthole	1

# Stand Alone ATM Doors Dual Locking Key Operation

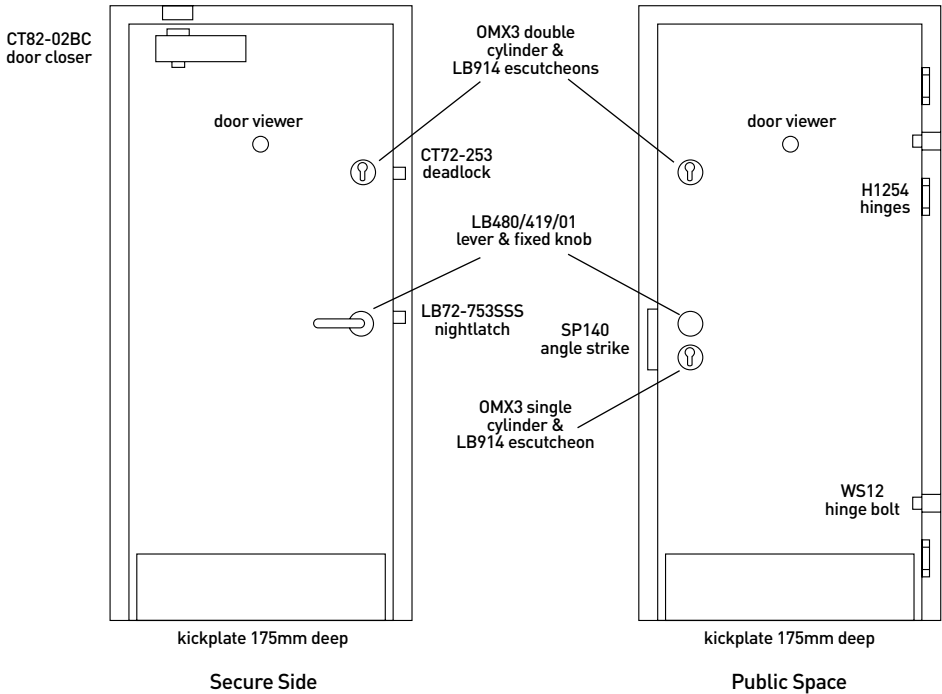

Lloyds	Dryad	Description	Qty
	H1254ES	125x93mm equal leaf fixed pin square cornered heavy duty	1.5
	LB72-753	Dryad Euro profile cylinder mortice nightlatch case SSS	1
	OMX3	45mm Euro profile single cylinder to differ SC	1
	LB72-253	Dryad Euro profile cylinder deadlock case SSS	1
	OMX2	70mm Euro profile double cylinder to differ SC	1
	SP140I	Angled strike plate SSS	1
	CT82-	Adjustable power overhead door closer with standard back-	1
	CT418/419/	External knob on rose fixed dead with internal lever on rose	1
	KICKPLATE	Kickplate 795x175mm SSS	1
	KICKPLATE	Kickplate 855X175mm SSS	1
	WS12	Chubb hinge bolts White (pair)	1
	N52715	Dryad 180dea door viewer with cover SCP	1
	LBCT914	Euro profile escutcheon SSS (each)	3



# Interlock ATM Pass Doors

(please note Interlock Pass doors have porthole fitted as above)

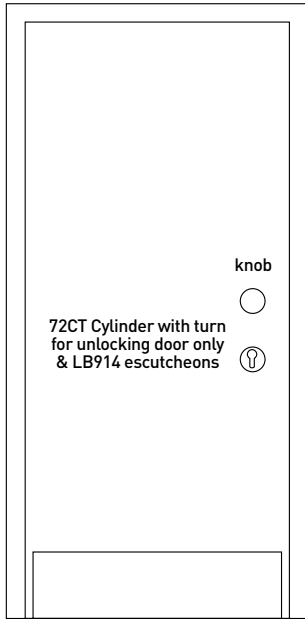

kickplate 175mm deep

**Secure Side**

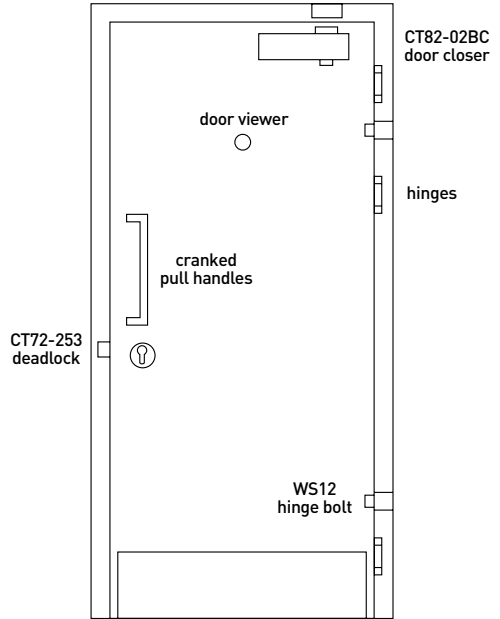

kickplate 175mm deep

**Attack Face**

Lloyds	Dryad	Description	Qty
	H1254ES	125x93mm equal leaf fixed pin square cornered heavy duty	1.5
	LB72-253	Dryad Euro profile cylinder deadlock case SSS	1
	OMX1	70mm Euro profile cylinder & turn to differ SC	1
	CT82-	Adjustable power overhead door closer with standard back-	1
	5825-50GL	50mm door knob with 8x8 spindle hole SSS	1
	T7I M413	FF5620 S 21 2 SSS 53x8mm rose 1/2 set	1
	KICKPLATE	Kickplate 795x175mm SSS	1
	KICKPLATE	Kickplate 855x175mm SSS	1
	WS12	Chubb hinge bolts White (pair)	1
ATM	N52715	Dryad 180dea door viewer with cover SCP	1
	LBCT914	Euro profile escutcheon SSS (each)	2
	T7I M301	300mm c/c 19mm diameter cranked pull handle SSS (pair) 1/2	1
		Roses 53x10mm for 19mm pull handles (pair)	1
		Mag Lock - By others	1

# Security Door Frame Fixing

**lock position 1**

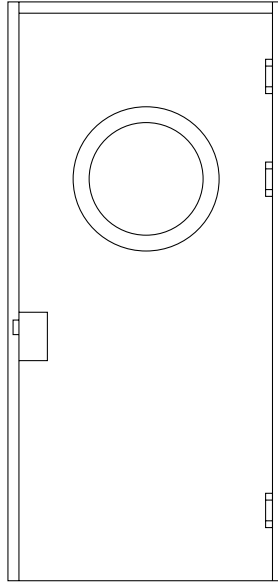

**2 hinge position**

For security reasons the door frames must have at least 3no. secure fixings to each leg of the door frame, the legs should be packed with a solid packing drilled through into a secure and solid wall.

Points **1** and **2** shown above **must** be packed with a solid packing through into a stable and solid wall to prevent the frame flexing if attacked with crow bars or similar levers.

## **Detail at closing edge showing Lock Protection Bar**

Bar factory fitted, removed to allow frame installation.  
Supplied loose for contractor to re-fix.

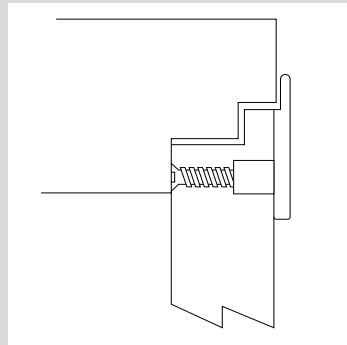



**S Barber & Co**  
Shopfitters Ltd

Bangor Terrace, Whitehall Road, Leeds LS12 5PS

Tel: 0113 2639996 Fax: 0113 2790158

gary@sbarber.co.uk www.sbarber.co.uk

**Specialists in Bank & Office Fittings, French Polishing, Bespoke Joinery & Office Refurbishment**

